

Approval body for construction products
and types of construction

Bautechnisches Prüfamt

An institution established by the Federal and
Laender Governments



European Technical Assessment

ETA-20/0603
of 13 November 2020

English translation prepared by DIBt - Original version in German language

General Part

Technical Assessment Body issuing the
European Technical Assessment:

Deutsches Institut für Bautechnik

Trade name of the construction product

fischer Injection system FIS V Plus

Product family
to which the construction product belongs

Bonded anchor for use in concrete

Manufacturer

fischerwerke GmbH & Co. KG
Otto-Hahn-Straße 15
79211 Denzlingen
DEUTSCHLAND

Manufacturing plant

fischerwerke

This European Technical Assessment
contains

37 pages including 3 annexes which form an integral part
of this assessment

This European Technical Assessment is
issued in accordance with Regulation (EU)
No 305/2011, on the basis of

EAD 330499-01-0601 Edition 04/2020

The European Technical Assessment is issued by the Technical Assessment Body in its official language. Translations of this European Technical Assessment in other languages shall fully correspond to the original issued document and shall be identified as such.

Communication of this European Technical Assessment, including transmission by electronic means, shall be in full. However, partial reproduction may only be made with the written consent of the issuing Technical Assessment Body. Any partial reproduction shall be identified as such.

This European Technical Assessment may be withdrawn by the issuing Technical Assessment Body, in particular pursuant to information by the Commission in accordance with Article 25(3) of Regulation (EU) No 305/2011.

Specific Part

1 Technical description of the product

The "fischer Injection system FIS V Plus" is a bonded anchor consisting of a cartridge with injection mortar according to Annex A 4 and a steel element according to Annex A 1 to A 3. The steel element is placed into a drilled hole filled with injection mortar and is anchored via the bond between metal part, injection mortar and concrete. The product description is given in Annex A.

2 Specification of the intended use in accordance with the applicable European Assessment Document

The performances given in Section 3 are only valid if the anchor is used in compliance with the specifications and conditions given in Annex B. The verifications and assessment methods on which this European Technical Assessment is based lead to the assumption of a working life of the anchor of at least 50 and/or 100 years. The indications given on the working life cannot be interpreted as a guarantee given by the producer, but are to be regarded only as a means for choosing the right products in relation to the expected economically reasonable working life of the works.

3 Performance of the product and references to the methods used for its assessment

3.1 Mechanical resistance and stability (BWR 1)

Essential characteristic	Performance
Characteristic resistance to tension load (static and quasi-static loading)	See Annex C 1, C 2, C 4 to C 9, B 4, B 5
Characteristic resistance to shear load (static and quasi-static loading)	See Annex C 1 to C 3
Displacements under short-term and long-term loading	See Annex C 10 to C 11
Characteristic resistance and displacements for seismic performance categories C1 and C2	See Annex C 12 to C 15

3.2 Hygiene, health and the environment (BWR 3)

Essential characteristic	Performance
Content, emission and/or release of dangerous substances	No performance assessed

English translation prepared by DIBt

4 Assessment and verification of constancy of performance (AVCP) system applied, with reference to its legal base

In accordance with the European Assessment Document EAD 330499-01-0601 the applicable European legal act is: [96/582/EC].

The system to be applied is: 1

5 Technical details necessary for the implementation of the AVCP system, as provided for in the applicable European Assessment Document

Technical details necessary for the implementation of the AVCP system are laid down in the control plan deposited at Deutsches Institut für Bautechnik.

Issued in Berlin 13 November 2020 by Deutsches Institut für Bautechnik

Dipl.-Ing. Beatrix Wittstock
Head of Section

beglaubigt:
Lange

Installation conditions part 1

fischer anchor rod

Pre-positioned installation

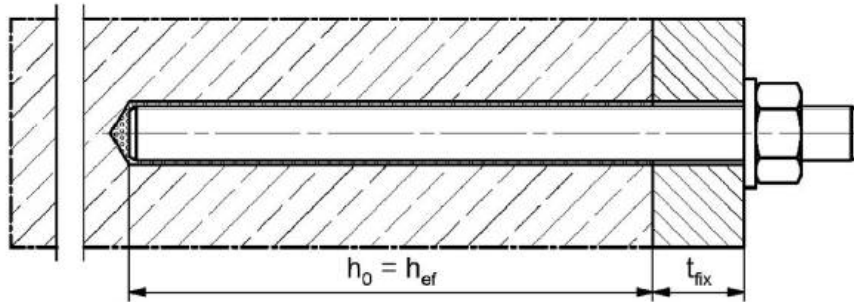

Push through installation (annular gap filled with mortar)

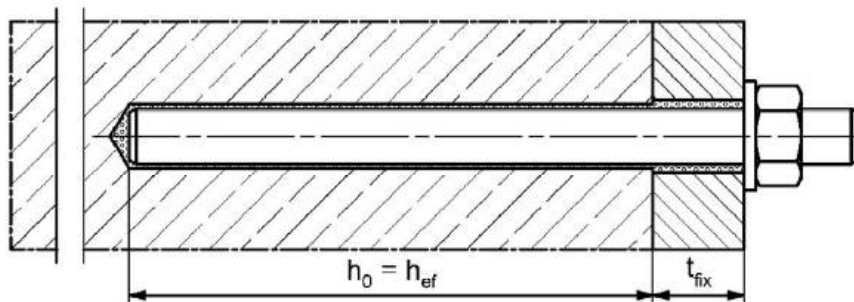

Pre-positioned or push through installation with subsequently injected fischer filling disc (annular gap filled with mortar)

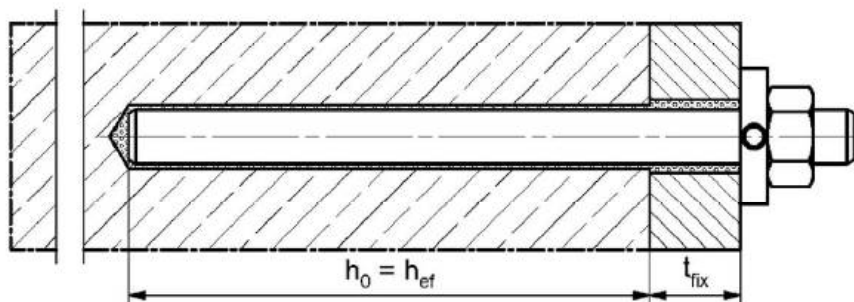

Figures not to scale

h_0 = drill hole depth

h_{ef} = effective embedment depth

t_{fix} = thickness of fixture

fischer injection system FIS V Plus

Product description
Installation conditions part 1

Annex A 1

Installation conditions part 2

fischer internal threaded anchor RG MI

Pre-positioned installation

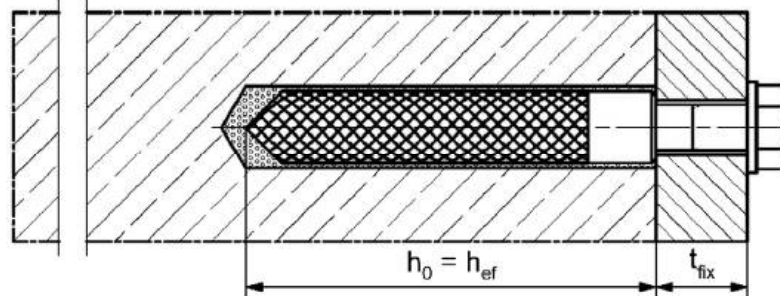

Pre-positioned installation with subsequently injected fischer filling disc (annular gap filled with mortar)

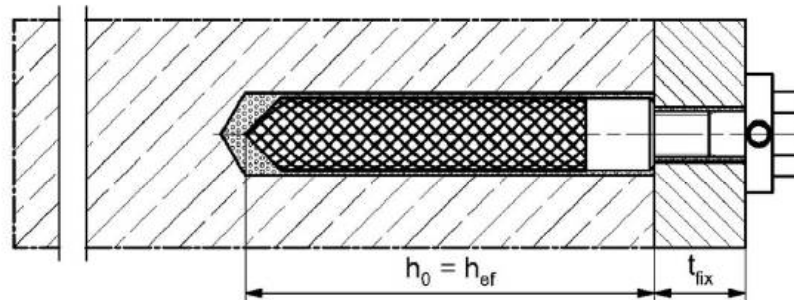

Figures not to scale

h_0 = drill hole depth

h_{ef} = effective embedment depth

t_{fix} = thickness of fixture

fischer injection system FIS V Plus

Product description
Installation conditions part 2

Annex A 2

Installation conditions part 3

Reinforcing bar

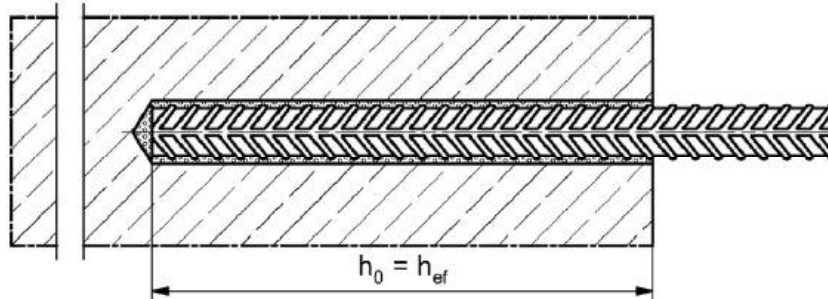

fischer rebar anchor FRA

Pre-positioned installation

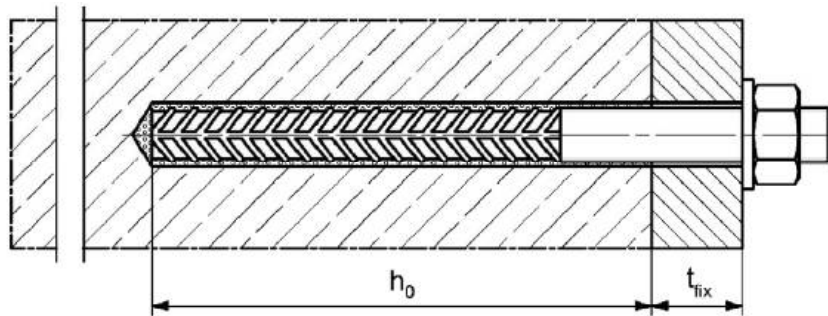

Push through installation (annular gap filled with mortar)

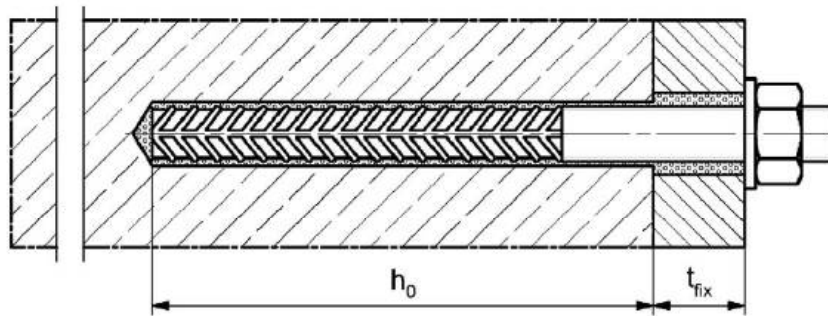

Figures not to scale

h_0 = drill hole depth

h_{ef} = effective embedment depth

t_{fix} = thickness of fixture

fischer injection system FIS V Plus

Product description
Installation conditions part 3

Annex A 3

Overview system components part 1

Injection cartridge (shuttle cartridge) with sealing cap; Sizes: 350 ml, 360 ml, 390 ml, 550 ml, 1100 ml, 1500 ml

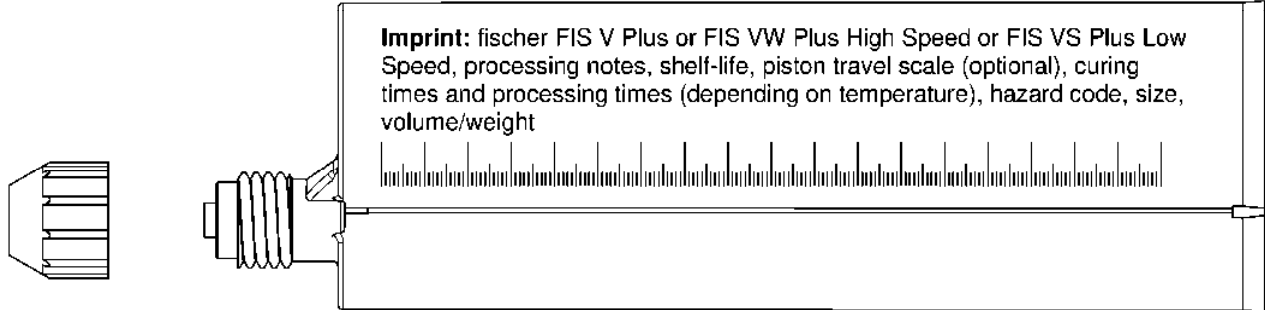

Injection cartridge (coaxial cartridge) with sealing cap; Sizes: 100 ml, 150 ml, 300 ml, 380 ml, 400 ml, 410 ml

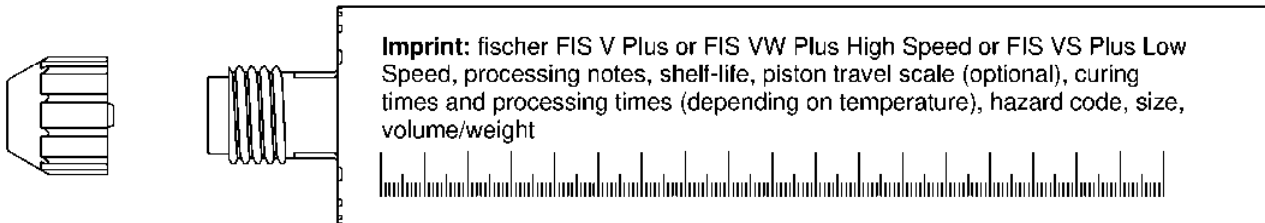

Static mixer FIS MR Plus for injection cartridges up to 410 ml

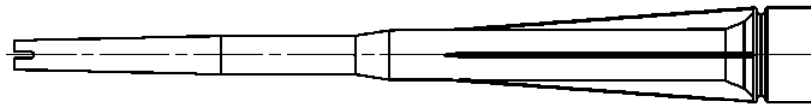

Static mixer FIS UMR for injection cartridges from 550 ml

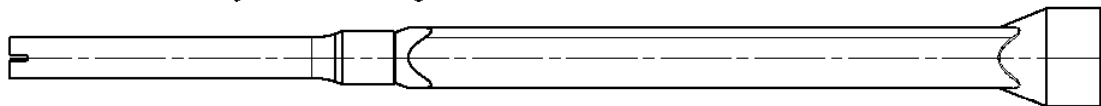

**Injection adapter and extension tube Ø 9 for static mixer FIS MR Plus;
Injection adapter and extension tube Ø 9 or Ø 15 for static mixer FIS UMR**

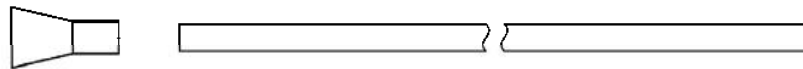

Cleaning brush BS



Blow-out pump

AB G:



ABP:



Figures not to scale

fischer injection system FIS V Plus

Product description

Overview system components part 1;
cartridges / static mixer / accessories

Annex A 4

Overview system components part 2

fischer anchor rod

Size: M6, M8, M10, M12, M16, M20, M24, M27, M30

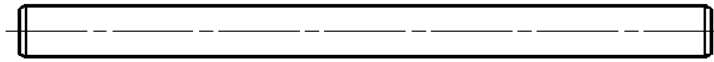

fischer internal threaded anchor RG MI

Size: M8, M10, M12, M16, M20



Screw / threaded rod / washer / hexagon nut

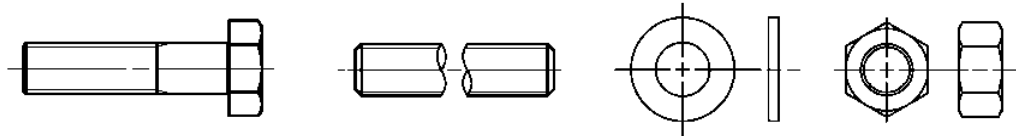

fischer filling disc with injection adapter

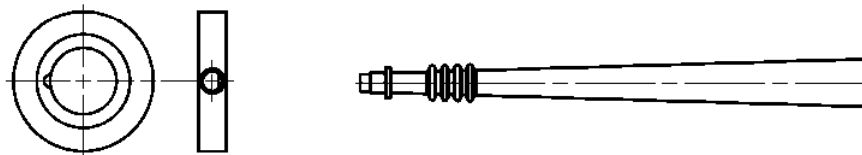

Reinforcing bar

Nominal diameter: $\phi 8$, $\phi 10$, $\phi 12$, $\phi 14$, $\phi 16$, $\phi 20$, $\phi 25$, $\phi 28$



fischer rebar anchor FRA

Size: M12, M16, M20, M24



Figures not to scale

fischer injection system FIS V Plus

Product description







Overview system components part 2;
metal parts, injection adapter

Annex A 5

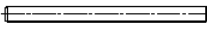
Part	Designation	Material		
1	Injection cartridge	Mortar, hardener, filler		
	Steel grade	Steel	Stainless steel R	High corrosion resistant steel HCR
		zinc plated	acc. to EN 10088-1:2014 Corrosion resistance class CRC III acc. to EN 1993-1-4:2015	acc. to EN 10088-1:2014 Corrosion resistance class CRC V acc. to EN 1993-1-4:2015
2	Anchor rod	Property class 4.8, 5.8 or 8.8; EN ISO 898-1:2013 zinc plated $\geq 5 \mu\text{m}$, ISO 4042:2018/Zn5/An(A2K) or hot dip galvanised $\geq 40 \mu\text{m}$ EN ISO 10684:2004 $f_{uk} \leq 1000 \text{ N/mm}^2$ $A_5 > 12\%$ fracture elongation	Property class 50, 70 or 80 EN ISO 3506-1:2009 1.4401; 1.4404; 1.4578; 1.4571; 1.4439; 1.4362; 1.4062, 1.4662, 1.4462; EN 10088-1:2014 $f_{uk} \leq 1000 \text{ N/mm}^2$ $A_5 > 12\%$ fracture elongation	Property class 50 or 80 EN ISO 3506-1:2009 or property class 70 with $f_{yk} = 560 \text{ N/mm}^2$ 1.4565; 1.4529; EN 10088-1:2014 $f_{uk} \leq 1000 \text{ N/mm}^2$ $A_5 > 12\%$ fracture elongation
		Fracture elongation $A_5 > 8\%$, for applications without requirements for seismic performance category C2		
3	Washer ISO 7089:2000	zinc plated $\geq 5 \mu\text{m}$, ISO 4042:2018/Zn5/An(A2K) or hot dip galvanised $\geq 40 \mu\text{m}$ EN ISO 10684:2004	1.4401; 1.4404; 1.4578; 1.4571; 1.4439; 1.4362; EN 10088-1:2014	1.4565; 1.4529; EN 10088-1:2014
4	Hexagon nut	Property class 4, 5 or 8; EN ISO 898-2:2012 zinc plated $\geq 5 \mu\text{m}$, ISO 4042:2018/Zn5/An(A2K) or hot dip galvanised $\geq 40 \mu\text{m}$ EN ISO 10684:2004	Property class 50, 70 or 80 EN ISO 3506-1:2009 1.4401; 1.4404; 1.4578; 1.4571; 1.4439; 1.4362; EN 10088-1:2014	Property class 50, 70 or 80 EN ISO 3506-1:2009 1.4565; 1.4529; EN 10088-1:2014
5	fischer internal threaded anchor RG MI	Property class 5.8 ISO 898-1:2013 zinc plated $\geq 5 \mu\text{m}$, ISO 4042:2018/Zn5/An(A2K)	Property class 70 EN ISO 3506-1:2009 1.4401; 1.4404; 1.4578; 1.4571; 1.4439; 1.4362; EN 10088-1:2014	Property class 70 EN ISO 3506-1:2009 1.4565; 1.4529; EN 10088-1:2014
6	Commercial standard screw or threaded rod for fischer internal threaded anchor RG MI	Property class 5.8 or 8.8; EN ISO 898-1:2013 zinc plated $\geq 5 \mu\text{m}$, ISO 4042:2018/Zn5/An(A2K) $A_5 > 8\%$ fracture elongation	Property class 70 EN ISO 3506-1:2009 1.4401; 1.4404; 1.4578; 1.4571; 1.4439; 1.4362; EN 10088-1:2014 $A_5 > 8\%$ fracture elongation	Property class 70 EN ISO 3506-1:2009 1.4565; 1.4529; EN 10088-1:2014 $A_5 > 8\%$ fracture elongation
7	fischer filling disc similar to DIN 6319-G	zinc plated $\geq 5 \mu\text{m}$, ISO 4042:2018/Zn5/An(A2K) or hot dip galvanised $\geq 40 \mu\text{m}$ EN ISO 10684:2004	1.4401; 1.4404; 1.4578; 1.4571; 1.4439; 1.4362; EN 10088-1:2014	1.4565; 1.4529; EN 10088-1:2014
8	Reinforcing bar EN 1992-1-1:2004 and AC:2010, Annex C	Bars and de-coiled rods, class B or C with f_{yk} and k according to NDP or NCL of according to EN 1992-1-1:2004/NA $f_{uk} = f_{tk} = k \cdot f_{yk}$		
9	fischer rebar anchor FRA	Rebar part: Bars and de-coiled rods class B or C with f_{yk} and k according to NDP or NCL of EN 1992-1-1:2004+AC:2010 $f_{uk} = f_{tk} = k \cdot f_{yk}$	Threaded part: Property class 70 or 80 EN ISO 3506-1:2009 1.4401, 1.4404, 1.4571, 1.4578, 1.4439, 1.4362, 1.4062 acc. to EN 10088-1:2014 Corrosion resistance class CRC III acc. to EN 1993-1-4:2015 1.4565; 1.4529 acc. to EN 10088-1:2014 Corrosion resistance class CRC V acc. to EN 1993-1-4:2015	
fischer injection system FIS V Plus				Annex A 6
Product description Materials				

Specifications of intended use (part 1)

Table B1.1: Overview use and performance categories

		FIS V Plus with ...							
		Anchor rod	fischer internal threaded anchor RG MI	Reinforcing bar	fischer rebar anchor FRA				
									
Hammer drilling with standard drill bit 		all sizes							
Hammer drilling with hollow drill bit  (fischer „FHD“, Heller „Duster Expert“, Bosch „Speed Clean“, Hilti „TE-CD, TE-YD“, DreBo „D-Plus“, DreBo „D-Max“)		Nominal drill bit diameter (d ₀) 12 mm to 35 mm							
Static and quasi static load, in	uncracked concrete	all sizes	Tables: C1.1 C4.1 C5.1 C6.1 C10.1	all sizes	Tables: C2.1 C4.1 C7.1 C10.2	all sizes	Tables: C3.1 C4.1 C8.1 C11.1	all sizes	Tables: C3.2 C4.1 C9.1 C11.2
	cracked concrete	M8 to M30		..2)		φ 10 to φ 28			
Seismic performance category	C1 ¹⁾	M10 to M30	Tables: C12.1 C13.1 C14.1	..2)		..2)		..2)	
	C2 ¹⁾	M12 M16 M20	Tables: C12.1 C13.1 C15.1						
Use category	I1 dry or wet concrete	all sizes							
	I2 water filled hole	M12 to M30		all sizes		..2)		..2)	
Installation direction		D3 (downward and horizontal and upwards (e.g. overhead) installation)							
Installation temperature		T _{i,min} = -10 °C to T _{i,max} = +40 °C							
In-service temperature	Temperature range I	-40 °C to +80 °C		(max. short term temperature +80 °C; max. long term temperature +50 °C)					
	Temperature range II	-40 °C to +120 °C		(max. short term temperature +120 °C; max. long term temperature +72 °C)					
¹⁾ Not for FIS VW Plus High Speed and FIS VS Plus Low Speed ²⁾ No performance assessed									
fischer injection system FIS V Plus								Annex B 1	
Intended use Specifications (part 1)									

Electronic copy of the ETA by DIBt: ETA-20/0603

Specifications of intended use (part 2)

Base materials:

- Compacted reinforced or unreinforced normal weight concrete without fibres of strength classes C20/25 to C50/60 according to EN 206:2013+A1:2016

Use conditions (Environmental conditions):

- Structures subject to dry internal conditions (zinc coated steel, stainless steel or high corrosion resistant steel).
- For all other conditions according to EN1993-1-4:2015 corresponding to corrosion resistance classes to Annex A 6 Table A6.1.

Design:

- Anchorages have to be designed by a responsible engineer with experience of concrete anchor design.
- Verifiable calculation notes and drawings are to be prepared taking account of the loads to be anchored. The position of the anchor is indicated on the design drawings (e. g. position of the anchor relative to reinforcement or to supports, etc.).
- Anchorages are designed in accordance with:
EN 1992-4:2018 and EOTA Technical Report TR 055, Edition February 2018.

Installation:

- Anchor installation is to be carried out by appropriately qualified personnel and under the supervision of the person responsible for technical matters of the site
- In case of aborted hole: The hole shall be filled with mortar
- Anchorage depth should be marked and adhered to on installation
- Overhead installation is allowed

fischer injection system FIS V Plus

Intended use
Specifications (part 2)

Annex B 2

Table B3.1: Installation parameters for **anchor rods** ¹⁾

Anchor rods		Thread	M6	M8	M10	M12	M16	M20	M24	M27	M30	
Width across flats	SW	[mm]	10	13	17	19	24	30	36	41	46	
Nominal drill hole diameter	d_0		8	10	12	14	18	24	28	30	35	
Drill hole depth	h_0		$h_0 = h_{ef}$									
Effective embedment depth	$h_{ef, min}$		50	60	60	70	80	90	96	108	120	
	$h_{ef, max}$		72	160	200	240	320	400	480	540	600	
Minimum spacing and minimum edge distance	s_{min} =		40	40	45	55	65	85	105	125	140	
	c_{min}											
Diameter of the clearance hole of the fixture	pre-positioned installation		d_r	7	9	12	14	18	22	26	30	33
	push through installation		d_r	9	12	14	16	20	26	30	33	40
Minimum thickness of concrete member	h_{min}		$h_{ef} + 30 (\geq 100)$					$h_{ef} + 2d_0$				
Maximum installation torque	$\max T_{inst}$	[Nm]	5	10	20	40	60	120	150	200	300	

¹⁾ minimum spacing and minimum edge distance see Annex B 4

fischer anchor rod

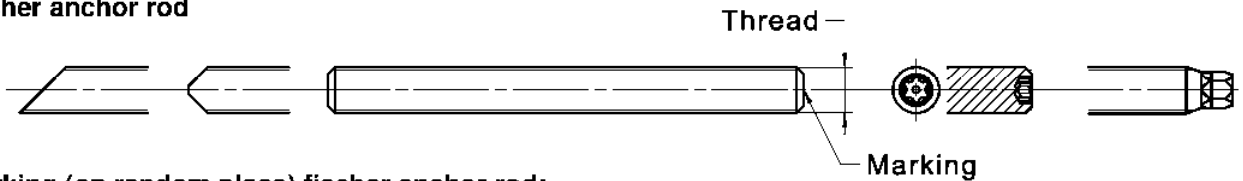

Marking (on random place) fischer anchor rod:

Steel zinc plated PC ¹⁾ 8.8	• or +	Steel hot-dip PC ¹⁾ 8.8	•
High corrosion resistant steel HCR PC ¹⁾ 50	•	High corrosion resistant steel HCR PC ¹⁾ 70	-
High corrosion resistant steel HCR PC ¹⁾ 80	(Stainless steel R property class 50	~
Stainless steel R property class 80	*		

Alternatively: Colour coding according to DIN 976-1: 2016

¹⁾ PC = property class

Installation conditions:

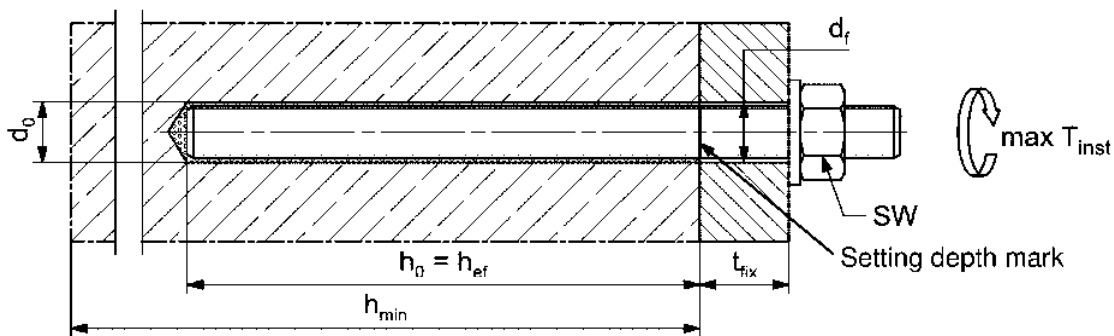

Commercial standard threaded rods, washers and hexagon nuts may also be used if the following requirements are fulfilled:

- Materials, dimensions and mechanical properties according to Annex A 6, Table A6.1
- Inspection certificate 3.1 according to EN 10204:2004, the documents have to be stored
- Setting depth is marked

Figures not to scale

fischer injection system FIS V Plus

Intended use
Installation parameters anchor rods

Annex B 3

Table B4.1: Minimum spacing and minimum edge distance for anchor rods, reinforcing bars and fischer rebar anchor FRA								
Anchor rods			M6	M8	M10	M12	-	M16
Reinforcing bars / FRA (nominal diameter)		ϕ	-	8	10	12	14	16
Minimum edge distance								
Uncracked / cracked concrete	C_{min}	[mm]	40	40	45	45	45	50
Minimum spacing	S_{min}		according to Annex B 5					
Minimum spacing								
Uncracked / cracked concrete	S_{min}	[mm]	40	40	45	55	60	65
Minimum edge distance	C_{min}		according to Annex B 5					
Required projecting area								
Uncracked concrete	$A_{sp,req}$	[1000 mm ²]	8,0	8,0	13,0	22,0	23,0	24,0
Cracked concrete			6,5	6,5	10	16,5	17,5	18,5
Anchor rods								
Anchor rods			M20	M24	-	M27	-	M30
Reinforcing bars / FRA (nominal diameter)		ϕ	20	-	25	-	28	-
Minimum edge distance								
Uncracked / cracked concrete	C_{min}	[mm]	55	60	75	75	80	80
Minimum spacing	S_{min}		according to Annex B 5					
Minimum spacing								
Uncracked / cracked concrete	S_{min}	[mm]	85	105	120	120	140	140
Minimum edge distance	C_{min}		according to Annex B 5					
Required projecting area								
Uncracked concrete	$A_{sp,req}$	[1000 mm ²]	38,5	40	47,5	47,5	64	64
Cracked concrete			29,5	30,5	36,5	36,5	49	49
<p>Splitting failure for minimum edge distance and spacing in dependence of the effective embedment depth h_{ef}.</p> <p>For the calculation of minimum spacing and minimum edge distance of anchors in combination with different embedment depths and thicknesses of concrete members the following equation shall be fulfilled:</p> $A_{sp,req} < A_{sp,t}$ <p>$A_{sp,req}$ = required projecting area $A_{sp,t} = A_{sp,ef}$ = effective projecting area (according to Annex B 5)</p>								
fischer injection system FIS V Plus							Annex B 4	
Intended use Minimum spacing and edge distance for anchor rods, reinforcing bars and fischer rebar anchor FRA								

Table B5.1: Effective projecting area $A_{sp,t}$ with concrete member thickness $h > h_{ef} + 1,5 \cdot c$ and $h \geq h_{min}$

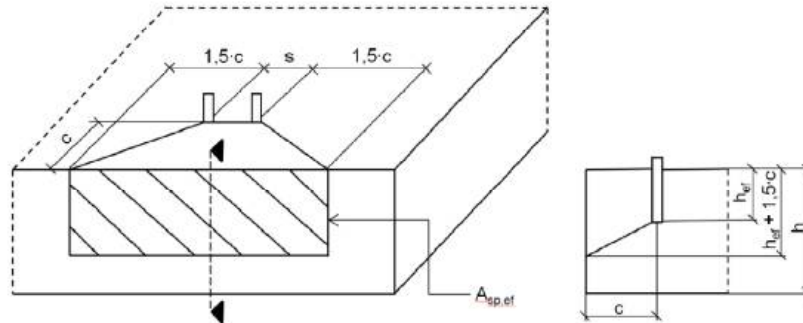

Single anchor	$A_{sp,t} = (3 \cdot c) \cdot (h_{ef} + 1,5 \cdot c)$	[mm ²]	with $c \geq c_{min}$
Group of anchors with $s > 3 \cdot c$	$A_{sp,t} = (6 \cdot c) \cdot (h_{ef} + 1,5 \cdot c)$	[mm ²]	
Group of anchors with $s \leq 3 \cdot c$	$A_{sp,t} = (3 \cdot c + s) \cdot (h_{ef} + 1,5 \cdot c)$	[mm ²]	

Table B5.2: Effektive projecting area $A_{sp,t}$ with concrete member thickness $h \leq h_{ef} + 1,5 \cdot c$ and $h \geq h_{min}$

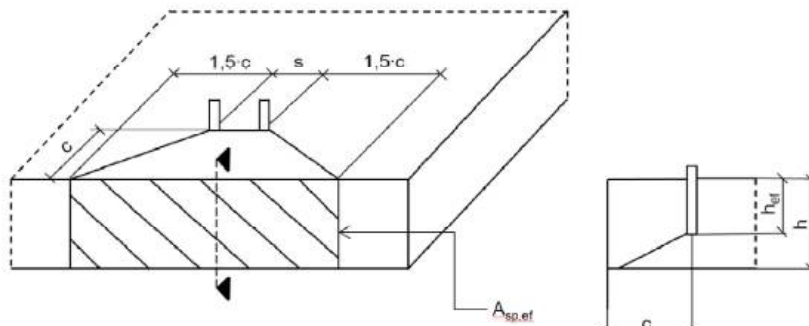

Single anchor	$A_{sp,t} = 3 \cdot c \cdot \text{existing } h$	[mm ²]	with $c \geq c_{min}$
Group of anchors with $s > 3 \cdot c$	$A_{sp,t} = 6 \cdot c \cdot \text{existing } h$	[mm ²]	
Group of anchors with $s \leq 3 \cdot c$	$A_{sp,t} = (3 \cdot c + s) \cdot \text{existing } h$	[mm ²]	

Edge distance and axial spacing shall be rounded up to at least 5 mm

Figures not to scale

fischer injection system FIS V Plus

Intended use

Minimum thickness of concrete member for anchor rods and reinforcing bars, minimum spacing and edge distance

Annex B 5

Table B6.1: Installation parameters for **fischer internal threaded anchors RG MI**

Internal threaded anchors RG MI		Thread	M8	M10	M12	M16	M20
Diameter of anchor	$d_{nom} = d_H$	[mm]	12	16	18	22	28
Nominal drill hole diameter	d_0		14	18	20	24	32
Drill hole depth	h_0		$h_0 = h_{ef} = L_H$				
Effective embedment depth ($h_{ef} = L_H$)	h_{ef}		90	90	125	160	200
Minimum spacing and minimum edge distance	$S_{min} = C_{min}$		55	65	75	95	125
Diameter of clearance hole in the fixture	d_f		9	12	14	18	22
Minimum thickness of concrete member	h_{min}		120	125	165	205	260
Maximum screw-in depth	$l_{E,max}$		18	23	26	35	45
Minimum screw-in depth	$l_{E,min}$		8	10	12	16	20
Maximum installation torque	$\max T_{inst}$		[Nm]	10	20	40	80

fischer internal threaded anchor RG MI

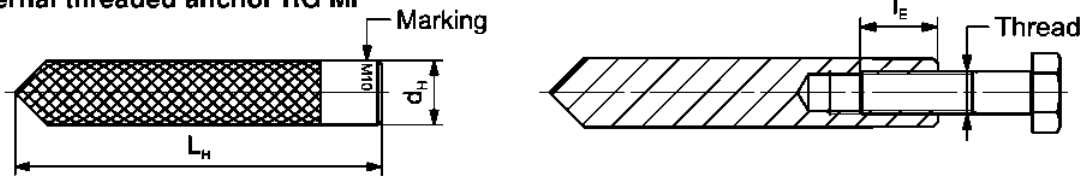

Marking: Anchor size e. g.: **M10**
Stainless steel → additional **R**; e.g.: **M10 R**
High corrosion resistant steel → additional **HCR**; e.g.: **M10 HCR**

Retaining bolt or threaded rods (including nut and washer) must comply with the appropriate material and strength class of Annex A 6, Table A6.1

Installation conditions:

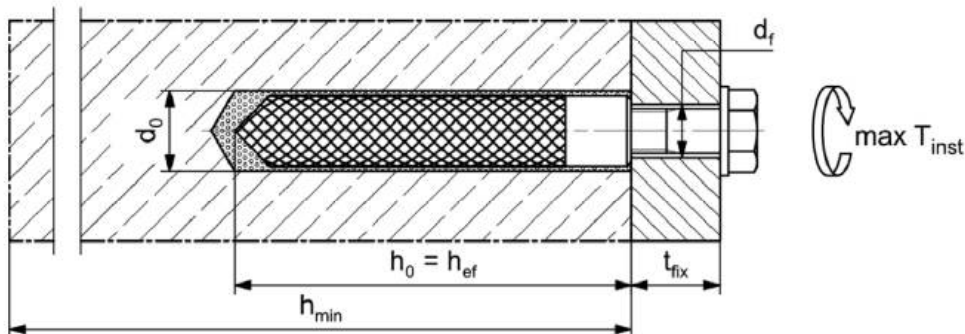

Figures not to scale

fischer injection system FIS V Plus

Intended use
Installation parameters internal threaded anchors RG MI

Annex B 6

Table B7.1: Installation parameters for reinforcing bars ¹⁾

Nominal diameter of the bar		ϕ	8 ²⁾	10 ²⁾	12 ²⁾	14	16	20	25	28	
Nominal drill hole diameter	d_0	[mm]	10	12	14	16	18	20	25	30	35
Drill hole depth	h_0		$h_0 = h_{ef}$								
Effective embedment depth	$h_{ef,min}$		60	60	70	75	80	90	100	112	
	$h_{ef,max}$		160	200	240	280	320	400	500	560	
Minimum spacing and minimum edge distance	s_{min} = c_{min}		40	45	55	60	65	85	110	130	
Minimum thickness of concrete member	h_{min}	$h_{ef} + 30$ (≥ 100)			$h_{ef} + 2d_0$						

¹⁾ minimum spacing and minimum edge distance see Annex B 4

²⁾ Both drill hole diameters can be used

Reinforcing bar



- The minimum value of related rib area $f_{R,min}$ must fulfil the requirements of EN 1992-1-1:2004+AC:2010
- The rib height must be within the range: $0,05 \cdot \phi \leq h_{rib} \leq 0,07 \cdot \phi$
(ϕ = Nominal diameter of the bar, h_{rib} = rib height)

Installation conditions:

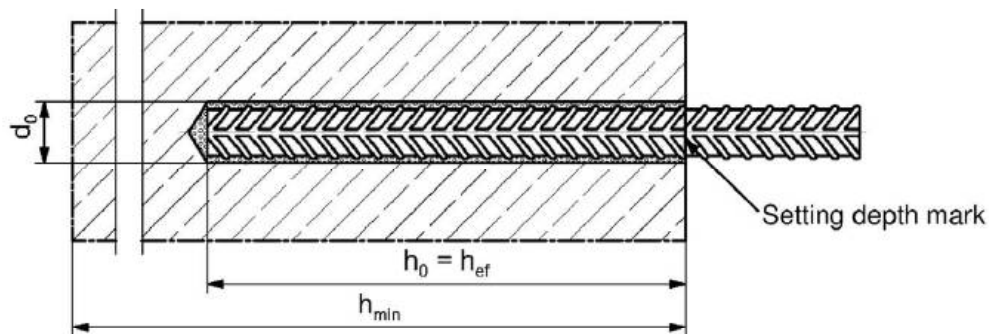

Figures not to scale

fischer injection system FIS V Plus

Intended use
Installation parameters reinforcing bars

Annex B 7

Table B8.1: Installation parameters for **fischer rebar anchor FRA** ¹⁾

Rebar anchor FRA		Thread	M12 ²⁾	M16	M20	M24
Nominal diameter of the bar	ϕ	[mm]	12	16	20	25
Width across flats	SW		19	24	30	36
Nominal drill hole diameter	d_0		14	16	20	30
Drill hole depth	h_0		$h_{ef} + l_e$			
Effective embedment depth	$h_{ef,min}$		70	80	90	96
	$h_{ef,max}$		140	220	300	380
Distance concrete surface to welded joint	l_e		100			
Minimum spacing and minimum edge distance	s_{min} = c_{min}		55	65	85	105
Diameter of clearance hole in the fixture	pre-positioned anchorage $\leq d_f$		14	18	22	26
	push through anchorage $\leq d_f$		18	22	26	32
Minimum thickness of concrete member	h_{min}	$h_0 + 30$	$h_0 + 2d_0$			
Maximum installation torque	$\max T_{inst}$	[Nm]	40	60	120	150

¹⁾ minimum spacing and minimum edge distance see Annex B 5

²⁾ Both drill hole diameters can be used

fischer rebar anchor FRA

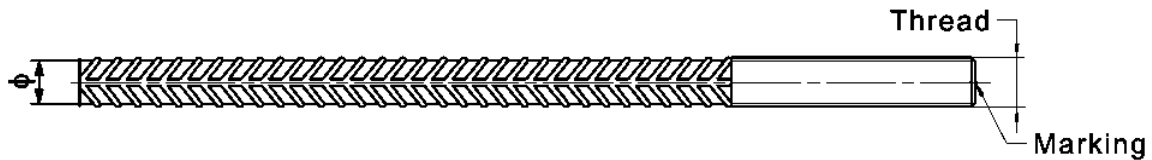

Marking frontal e.g: FRA (for stainless steel);
FRA HCR (for high corrosion resistant steel)

Installation conditions:

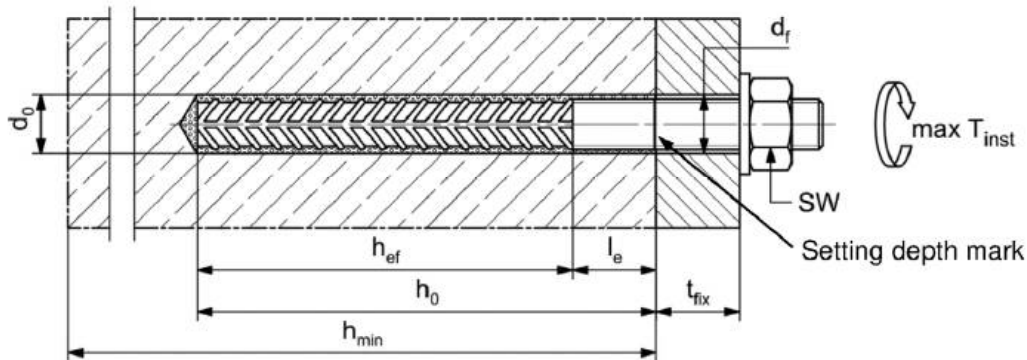

Figures not to scale

fischer injection system FIS V Plus

Intended use
Installation parameters rebar anchor FRA

Annex B 8

Table B9.1: Parameters of the **cleaning brush BS** (steel brush with steel bristles)

The size of the cleaning brush refers to the drill hole diameter

Nominal drill hole diameter	d_0		8	10	12	14	16	18	20	24	25	28	30	35
Steel brush diameter	d_b	[mm]	9	11	14	16	20	25	26	27	30	40		

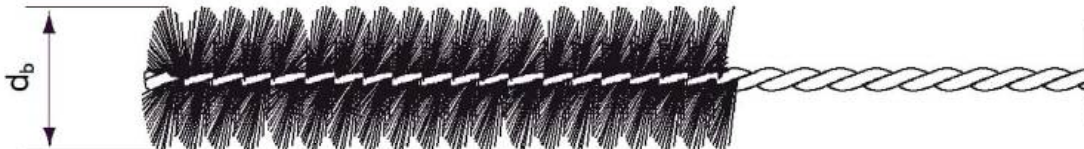

Table B9.2 **Maximum processing** time of the mortar and **minimum curing** time
(During the curing time of the mortar the concrete temperature may not fall below the listed minimum temperature)

Temperature at anchoring base [°C]	Maximum processing time t_{work}			Minimum curing time ¹⁾ t_{cure}		
	FIS VW Plus High Speed	FIS V Plus	FIS VS Plus Low Speed	FIS VW Plus High Speed	FIS V Plus	FIS VS Plus Low Speed
-10 to -5 ²⁾	-	-	-	12 h	-	-
> -5 to 0 ²⁾	5 min	-	-	3 h	24 h	-
> 0 to 5 ²⁾	5 min	13 min	-	3 h	3 h	6 h
> 5 to 10	3 min	9 min	20 min	50 min	90 min	3 h
> 10 to 20	1 min	5 min	10 min	30 min	60 min	2 h
> 20 to 30	-	4 min	6 min	-	45 min	60 min
> 30 to 40	-	2 min	4 min	-	35 min	30 min



¹⁾ In wet concrete or water filled holes the curing times must be doubled



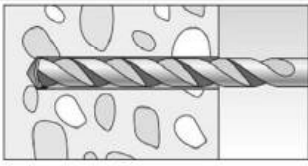
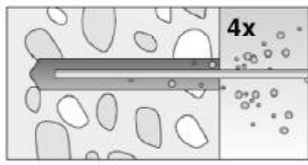
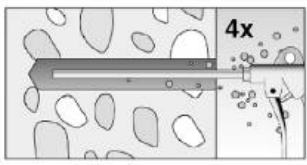
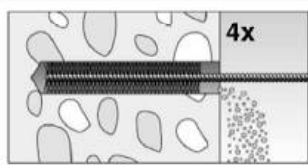
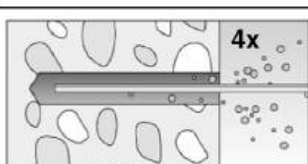
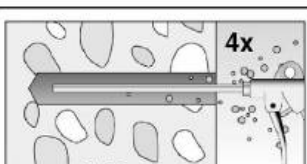

²⁾ Minimal cartridge temperature +5°C

fischer injection system FIS V Plus

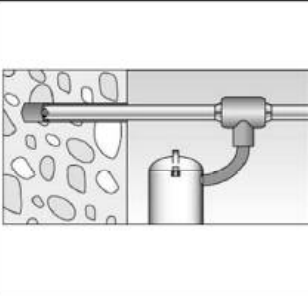
Intended use
Cleaning brush (steel brush)
Processing time and curing time

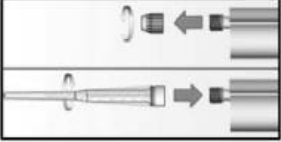
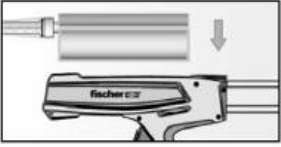
Annex B 9

Installation instructions part 1	
Drilling and cleaning the hole (hammer drilling with standard drill bit)	
1	 <p>Drill the hole. Nominal drill hole diameter d_0 and drill hole depth h_0 see tables B3.1, B6.1, B7.1, B8.1</p>
2	 <p>4x</p> <p>Clean the drill hole: For $h_{ef} \leq 12d$ and $d_0 < 18$ mm blow out the hole four times by hand</p>  <p>4x</p> <p>For $h_{ef} > 12d$ and / or $d_0 \geq 18$ mm blow out the hole four times with oil-free compressed air ($p \geq 6$ bar)</p>
3	 <p>4x</p> <p>Brush the drill hole four times. For drill hole diameter ≥ 30 mm use a power drill. For deep holes use an extension. Corresponding brushes see table B9.1</p>
4	 <p>4x</p> <p>Clean the drill hole: For $h_{ef} \leq 12d$ and $d_0 < 18$ mm blow out the hole four times by hand</p>  <p>4x</p> <p>For $h_{ef} > 12d$ and / or $d_0 \geq 18$ mm blow out the hole four times with oil-free compressed air ($p \geq 6$ bar)</p>
Go to step 5	
Drilling and cleaning the hole (hammer drilling with hollow drill bit)	
1	 <p>Check a suitable hollow drill (see table B1.1) for correct operation of the dust extraction</p>
2	 <p>Use a suitable dust extraction system, e.g. fischer FVC 35 M or a comparable dust extraction system with equivalent performance data</p> <p>Drill the hole with hollow drill bit. The dust extraction system has to extract the drill dust nonstop during the drilling process and must be adjusted to maximum power. Nominal drill hole diameter d_0 and drill hole depth h_0 see tables B3.1, B6.1, B7.1, B8.1</p>
Go to step 5	
fischer injection system FIS V Plus	
Intended use Installation instructions part 1	
Annex B 10	

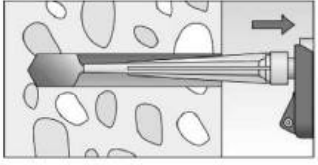
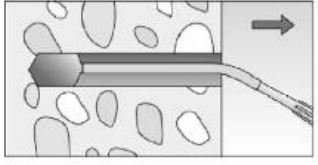
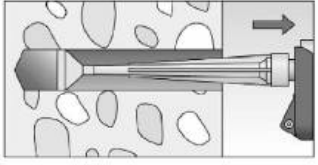
Installation instructions part 2				
Preparing the cartridge				
5		<p>Remove the sealing cap</p> <p>Screw on the static mixer (the spiral in the static mixer must be clearly visible)</p>		
6			Place the cartridge into the dispenser	
7			Extrude approximately 10 cm of material out until the resin is evenly grey in colour. Do not use mortar that is not uniformly grey	
Go to step 8				
Injection of the mortar				
8				<p>Fill approximately 2/3 of the drill hole with mortar. Always begin from the bottom of the hole and avoid bubbles</p> <p>For drill hole depth ≥ 150 mm use an extension tube</p> <p>For overhead installation, deep holes ($h_0 > 250$ mm) or drill hole diameter ($d_0 \geq 40$ mm) use an injection adapter</p>
Go to step 9				
fischer injection system FIS V Plus		Annex B 11		
Intended use Installation instructions part 2				





Installation instructions part 3			
Installation of anchor rods or fischer internal threaded anchors RG MI			
9		<p>Only use clean and oil-free metal parts. Mark the setting depth of the metal part. Push the anchor rod or fischer internal threaded RG MI anchor down to the bottom of the hole, turning it slightly while doing so. After inserting the metal parts, excess mortar must be emerged around the anchor element.</p>	
	 <p>For overhead installations support the metal part with wedges (e.g. fischer centering wedges) or fischer overhead clips.</p>	 <p>For push through installation fill the annular gap with mortar</p>	
10	 <p>Wait for the specified curing time t_{cure} see table B9.2</p>	11	 <p>Mounting the fixture max T_{inst} see tables B3.1 and B6.1</p>
Option		<p>After the minimum curing time is reached, the gap between metal part and fixture (annular clearance) may be filled with mortar via the fischer filling disc. Compressive strength $\geq 50 \text{ N/mm}^2$ (e.g. fischer injection mortars FIS HB, FIS SB, FIS V, FIS V Plus, FIS EM Plus). ATTENTION: Using fischer filling disc reduces t_{fix} (usable length of the anchor)</p>	
Installation reinforcing bars and fischer rebar anchor FRA			
9		<p>Only use clean and oil-free reinforcing bars or fischer FRA. Mark the setting depth. Turn while using force to push the reinforcement bar or the fischer FRA into the filled hole up to the setting depth mark.</p>	
	 <p>When the setting depth mark is reached, excess mortar must be emerged from the mouth of the drill hole.</p>		
10	 <p>Wait for the specified curing time t_{cure} see table B9.2</p>	11	 <p>Mounting the fixture max T_{inst} see table B8.1</p>
fischer injection system FIS V Plus			Annex B 12
Intended use Installation instructions part 3			

Table C1.1: Characteristic values for steel failure under tension / shear load of fischer anchor rods and standard threaded rods												
Anchor rod / standard threaded rod			M6	M8	M10	M12	M16	M20	M24	M27	M30	
Bearing capacity under tension load, steel failure ³⁾												
Characteristic resistance $N_{Rk,s}$	Steel zinc plated	Property class	4.8	8	15(13)	23(21)	33	63	98	141	184	224
			5.8	10	19(17)	29(27)	43	79	123	177	230	281
			8.8	16	29(27)	47(43)	68	126	196	282	368	449
	Stainless steel R and high corrosion resistant steel HCR		50	10	19	29	43	79	123	177	230	281
			70	14	26	41	59	110	172	247	322	393
			80	16	30	47	68	126	196	282	368	449
Partial factors ¹⁾												
Partial factor $\gamma_{Ms,N}$	Steel zinc plated	Property class	4.8	1,50								
			5.8	1,50								
			8.8	1,50								
	Stainless steel R and high corrosion resistant steel HCR		50	2,86								
			70	1,50 ²⁾ / 1,87								
			80	1,60								
Bearing capacity under shear load, steel failure ³⁾												
without lever arm												
Characteristic resistance $V_{Rk,s}^0$	Steel zinc plated	Property class	4.8	4	9(8)	14(13)	20	38	59	85	110	135
			5.8	6	11(10)	17(16)	25	47	74	106	138	168
			8.8	8	15(13)	23(21)	34	63	98	141	184	225
	Stainless steel R and high corrosion resistant steel HCR		50	5	9	15	21	39	61	89	115	141
			70	7	13	20	30	55	86	124	161	197
			80	8	15	23	34	63	98	141	184	225
Ductility factor		k_7	[-] 1,0									
with lever arm												
Characteristic resistance $M_{Rk,s}^0$	Steel zinc plated	Property class	4.8	6	15(13)	30(27)	52	133	259	448	665	899
			5.8	7	19(16)	37(33)	65	166	324	560	833	1123
			8.8	12	30(26)	60(53)	105	266	519	896	1333	1797
	Stainless steel R and high corrosion resistant steel HCR		50	7	19	37	65	166	324	560	833	1123
			70	10	26	52	92	232	454	784	1167	1573
			80	12	30	60	105	266	519	896	1333	1797
Partial factors ¹⁾												
Partial factor $\gamma_{Ms,V}$	Steel zinc plated	Property class	4.8	1,25								
			5.8	1,25								
			8.8	1,25								
	Stainless steel R and high corrosion resistant steel HCR		50	2,38								
			70	1,25 ²⁾ / 1,56								
			80	1,33								
¹⁾ In absence of other national regulations ²⁾ Only admissible for high corrosion resist. steel HCR, with $f_{yk} / f_{uk} \geq 0,8$ and $A_s > 12\%$ (e.g. fischer anchor rods) ³⁾ Values in brackets are valid for undersized threaded rods with smaller stress area A_s for hot dip galvanised standard threaded rods according to EN ISO 10684:2004+AC:2009												
fischer injection system FIS V Plus										Annex C 1		
Performances Characteristic values for steel failure under tension / shear load of fischer anchor rods and standard threaded rods												

Table C2.1: Characteristic values for steel failure under tension / shear load of fischer internal threaded anchors RG MI								
fischer internal threaded anchors RG MI			M8	M10	M12	M16	M20	
Bearing capacity under tension load, steel failure								
Charact. resistance with screw	$N_{Rk,s}$	Property class 5.8	[kN]	19	29	43	79	123
		8.8		29	47	68	108	179
		Property class 70 R		26	41	59	110	172
		HCR		26	41	59	110	172
Partial factors¹⁾								
Partial factors	$\gamma_{Ms,N}$	Property class 5.8	[-]	1,50				
		8.8		1,50				
		Property class 70 R		1,87				
		HCR		1,87				
Bearing capacity under shear load, steel failure								
Without lever arm								
Charact. resistance with screw	$V^0_{Rk,s}$	Property class 5.8	[kN]	9,2	14,5	21,1	39,2	62,0
		8.8		14,6	23,2	33,7	54,0	90,0
		Property class 70 R		12,8	20,3	29,5	54,8	86,0
		HCR		12,8	20,3	29,5	54,8	86,0
Ductility factor		k_7	[-]	1,0				
With lever arm								
Charact. resistance with screw	$M^0_{Rk,s}$	Property class 5.8	[Nm]	20	39	68	173	337
		8.8		30	60	105	266	519
		Property class 70 R		26	52	92	232	454
		HCR		26	52	92	232	454
Partial factors¹⁾								
Partial factors	$\gamma_{Ms,V}$	Property class 5.8	[-]	1,25				
		8.8		1,25				
		Property class 70 R		1,56				
		HCR		1,56				
1) In absence of other national regulations								
fischer injection system FIS V Plus							Annex C 2	
Performances Characteristic values for steel failure under tension / shear load of fischer internal threaded anchor RG MI								

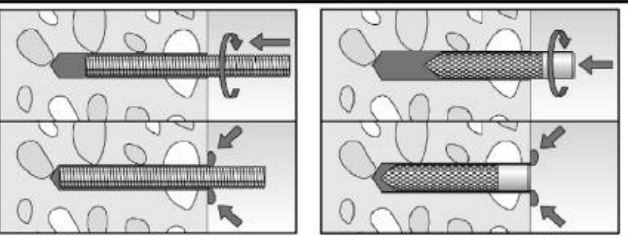
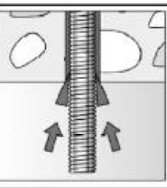
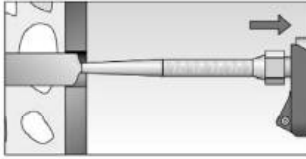
Table C3.1: Characteristic values for steel failure under tension / shear load of reinforcing bars									
Nominal diameter of the bar	ϕ	8	10	12	14	16	20	25	28
Bearing capacity under tension load, steel failure									
Characteristic resistance	$N_{Rk,s}$	[kN]	$A_s \cdot f_{uk}^{1)}$						
Bearing capacity under shear load, steel failure									
Without lever arm									
Characteristic resistance	$V^0_{Rk,s}$	[kN]	$0,5 \cdot A_s \cdot f_{uk}^{1)}$						
Ductility factor	k_7	[-]	1,0						
With lever arm									
Characteristic resistance	$M^0_{Rk,s}$	[Nm]	$1,2 \cdot W_{el} \cdot f_{uk}^{1)}$						
¹⁾ f_{uk} or f_{yk} respectively must be taken from the specifications of the reinforcing bar									
Table C3.2: Characteristic values for steel failure under tension / shear load of fischer rebar anchors FRA									
fischer rebar anchor FRA		M12	M16	M20	M24				
Bearing capacity under tension load, steel failure									
Characteristic resistance	$N_{Rk,s}$	[kN]	63	111	173	270			
Partial factor¹⁾									
Partial factor	$\gamma_{Ms,N}$	[-]	1,4						
Bearing capacity under shear load, steel failure									
Without lever arm									
Characteristic resistance	$V^0_{Rk,s}$	[kN]	30	55	86	124			
Ductility factor	k_7	[-]	1,0						
With lever arm									
Characteristic resistance	$M^0_{Rk,s}$	[Nm]	92	233	454	785			
Partial factor¹⁾									
Partial factor	$\gamma_{Ms,V}$	[-]	1,56						
¹⁾ In absence of other national regulations									
fischer injection system FIS V Plus							Annex C 3		
Performances Characteristic values for steel failure under tension / shear load of reinforcing bars and fischer rebar anchors FRA									

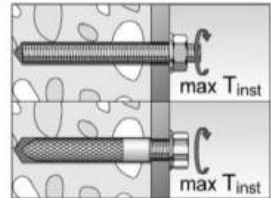
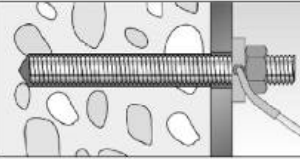
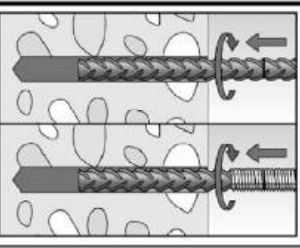
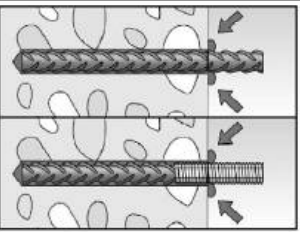
Table C4.1: Characteristic values for concrete failure under tension / shear load									
Size		All sizes							
Tension load									
Installation factor		γ_{inst}	[-]		See annex C 5 to C 12 and C 17 to C 18				
Factors for the compressive strength of concrete > C20/25									
Increasing factor for τ_{Rk}	C25/30		Ψ_c	[-]	1,05				
	C30/37				1,10				
	C35/45				1,15				
	C40/50				1,19				
	C45/55				1,22				
	C50/60				1,26				
Splitting failure									
Edge distance	$h / h_{ef} \geq 2,0$		$C_{cr,sp}$	[mm]	1,0 h_{ef}				
	$2,0 > h / h_{ef} > 1,3$				4,6 $h_{ef} - 1,8 h$				
	$h / h_{ef} \leq 1,3$				2,26 h_{ef}				
Spacing		$S_{cr,sp}$	2 $C_{cr,sp}$						
Concrete failure									
Uncracked concrete		$k_{ucr,N}$	[-]	11,0					
Cracked concrete		$k_{cr,N}$		7,7					
Edge distance		$C_{cr,N}$	[mm]	1,5 h_{ef}					
Spacing		$S_{cr,N}$		2 $C_{cr,N}$					
Factors for sustained tension load									
Temperature range		[-]		50 °C / 80 °C			72 °C / 120 °C		
Factor		Ψ_{sUS}^0	[-]		0,76			0,78	
Shear load									
Installation factor		γ_{inst}	[-]		1,0				
Concrete pry-out failure									
Factor for pry-out failure		k_8	[-]		2,0				
Concrete edge failure									
Effective length of fastener in shear loading		l_f	[mm]	for $d_{nom} \leq 24$ mm: min (h_{ef} ; 12 d_{nom}) for $d_{nom} > 24$ mm: min (h_{ef} ; 8 d_{nom} ; 300 mm)					
Calculation diameters									
Size		M6 M8 M10 M12 M16 M20 M24 M27 M30							
fisher anchor rods and standard threaded rods		d_{nom}	6 8 10 12 16 20 24 27 30						
fisher internal threaded anchors RG MI		d_{nom}	-1) 12 16 18 22 28 -1) -1) -1)						
fisher rebar anchor FRA		d_{nom}	-1) -1) -1) 12 16 20 25 -1) -1)						
Size (nominal diameter of the bar)		ϕ	8 10 12 14 16 20 25 28						
Reinforcing bar		d_{nom}	8 10 12 14 16 20 25 28						
1) Size of anchor type not part of the assessment									
fisher injection system FIS V Plus								Annex C 4	
Performances		Characteristic values for concrete failure under tension / shear load							

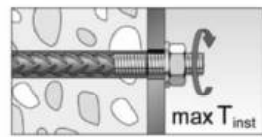
Table C5.1: Characteristic values for combined pull-out and concrete failure for fischer anchor rods and standard threaded rods in hammer drilled holes; uncracked or cracked concrete; working life 50 years													
Anchor rod / standard threaded rod		M6	M8	M10	M12	M16	M20	M24	M27	M30			
Combined pullout and concrete cone failure													
Calculation diameter	d	[mm]	6	8	10	12	16	20	24	27	30		
Uncracked concrete													
Characteristic bond resistance in uncracked concrete C20/25													
<u>Hammer-drilling with standard drill bit or hollow drill bit (dry or wet concrete)</u>													
Tem- perature range	I: 50 °C / 80 °C		$\tau_{Rk,ucr}$	[N/mm ²]	9,0	16,0	16,0	15,0	14,0	12,0	11,0	10,0	9,0
	II: 72 °C / 120 °C				6,5	15,0	14,0	13,0	12,0	11,0	9,0	8,0	8,0
<u>Hammer-drilling with standard drill bit or hollow drill bit (water filled hole)</u>													
Tem- perature range	I: 50 °C / 80 °C		$\tau_{Rk,ucr}$	[N/mm ²]	-1)	-1)	-1)	9,5	8,5	8,0	7,5	7,0	7,0
	II: 72 °C / 120 °C				-1)	-1)	-1)	7,5	7,0	6,5	6,0	6,0	6,0
Installation factors													
Dry or wet concrete	γ_{inst}	[-]	1,0										
Water filled hole	γ_{inst}	[-]	-1)	-1)	-1)	1,2							
Cracked concrete													
Characteristic bond resistance in cracked concrete C20/25													
<u>Hammer-drilling with standard drill bit or hollow drill bit (dry or wet concrete)</u>													
Tem- perature range	I: 50 °C / 80 °C		$\tau_{Rk,cr}$	[N/mm ²]	-1)	5,5	6,0	6,5	6,0	5,5	5,0	5,0	4,5
	II: 72 °C / 120 °C				-1)	4,5	5,0	6,0	5,5	5,0	4,5	4,0	4,0
<u>Hammer-drilling with standard drill bit or hollow drill bit (water filled hole)</u>													
Tem- perature range	I: 50 °C / 80 °C		$\tau_{Rk,cr}$	[N/mm ²]	-1)	-1)	-1)	5,0	5,0	4,5	4,0	3,5	3,5
	II: 72 °C / 120 °C				-1)	-1)	-1)	4,0	4,0	4,0	3,5	3,0	3,0
Installation factors													
Dry or wet concrete	γ_{inst}	[-]	1,0										
Water filled hole	γ_{inst}	[-]	-1)	-1)	-1)	1,2							
1) No performance assessed													
fischer injection system FIS V Plus										Annex C 5			
Performances Characteristic values for combined pull-out and concrete failure for fischer anchor rod and standard threaded rods; working life 50 years													

Table C6.1: Characteristic values for combined pull-out and concrete failure for fischer anchor rods and standard threaded rods in hammer drilled holes; uncracked or cracked concrete; working life 100 years											
Anchor rod / standard threaded rod		M6	M8	M10	M12	M16	M20	M24	M27	M30	
Combined pullout and concrete cone failure											
Calculation diameter	d [mm]	6	8	10	12	16	20	24	27	30	
Uncracked concrete											
Characteristic bond resistance in uncracked concrete C20/25											
<u>Hammer-drilling with standard drill bit or hollow drill bit (dry or wet concrete)</u>											
Tem- perature range	I: 50 °C / 80 °C	$\tau_{Rk,100,ucr}$ [N/mm ²]	-1)	16,0	16,0	15,0	14,0	12,0	11,0	10,0	9,0
	II: 72 °C / 120 °C		-1)	15,0	14,0	13,0	12,0	11,0	9,0	8,0	8,0
<u>Hammer-drilling with standard drill bit or hollow drill bit (water filled hole)</u>											
Tem- perature range	I: 50 °C / 80 °C	$\tau_{Rk,100,ucr}$ [N/mm ²]	-1)	-1)	-1)	9,5	8,5	8,0	7,5	7,0	7,0
	II: 72 °C / 120 °C		-1)	-1)	-1)	7,5	7,0	6,5	6,0	6,0	6,0
Installation factors											
Dry or wet concrete	γ_{inst}	[-]	1,0								
Water filled hole			-1)	-1)	-1)	1,2					
Cracked concrete											
Characteristic bond resistance in cracked concrete C20/25											
<u>Hammer-drilling with standard drill bit or hollow drill bit (dry or wet concrete)</u>											
Tem- perature range	I: 50 °C / 80 °C	$\tau_{Rk,100,cr}$ [N/mm ²]	-1)	5,0	5,5	5,5	5,5	5,5	5,0	5,0	4,5
	II: 72 °C / 120 °C		-1)	4,5	5,0	5,0	5,0	5,0	4,0	4,0	4,0
<u>Hammer-drilling with standard drill bit or hollow drill bit (water filled hole)</u>											
Tem- perature range	I: 50 °C / 80 °C	$\tau_{Rk,100,cr}$ [N/mm ²]	-1)	-1)	-1)	4,5	4,5	4,5	4,0	3,5	3,5
	II: 72 °C / 120 °C		-1)	-1)	-1)	4,0	4,0	4,0	3,5	3,0	3,0
Installation factors											
Dry or wet concrete	γ_{inst}	[-]	1,0								
Water filled hole			-1)	-1)	-1)	1,2					
1) No performance assessed											
fischer injection system FIS V Plus										Annex C 6	
Performances Characteristic values for combined pull-out and concrete failure for fischer anchor rod and standard threaded rods; working life 100 years											

Table C7.1: Characteristic values for combined pull-out and concrete failure for fischer internal threaded anchors RG MI in hammer drilled holes; uncracked concrete; working life 50 years

Internal threaded anchor RG MI		M8	M10	M12	M16	M20	
Combined pullout and concrete cone failure							
Calculation diameter	d [mm]	12	16	18	22	28	
Uncracked concrete							
Characteristic bond resistance in uncracked concrete C20/25							
<u>Hammer-drilling with standard drill bit or hollow drill bit (dry or wet concrete)</u>							
Tem- perature range	I: 50 °C / 80 °C	$\tau_{Rk,ucr}$ [N/mm ²]	10,5	10,0	9,5	9,0	8,5
	II: 72 °C / 120 °C		9,0	8,0	8,0	7,5	7,0
<u>Hammer-drilling with standard drill bit or hollow drill bit (water filled hole)</u>							
Tem- perature range	I: 50 °C / 80 °C	$\tau_{Rk,ucr}$ [N/mm ²]	10,0	9,0	9,0	8,5	8,0
	II: 72 °C / 120 °C		7,5	6,5	6,5	6,0	6,0
Installation factors							
Dry or wet concrete	γ_{inst}	[-]	1,0				
Water filled hole			1,2				
fischer injection system FIS V Plus						Annex C 7	
Performances Characteristic values for combined pull-out and concrete failure for fischer internal threaded anchors RG MI; working life 50 years							

Table C8.1: Characteristic values for combined pull-out and concrete failure for reinforcing bars in hammer drilled holes; uncracked or cracked concrete; working life 50 years												
Nominal diameter of the bar		ϕ	8	10	12	14	16	20	25	28		
Combined pullout and concrete cone failure												
Calculation diameter		d	[mm]	8	10	12	14	16	20	25	28	
Uncracked concrete												
Characteristic bond resistance in uncracked concrete C20/25												
<u>Hammer-drilling with standard drill bit or hollow drill bit (dry or wet concrete)</u>												
Tem- perature range	I: 50 °C / 80 °C		$\tau_{Rk,ucr}$	[N/mm ²]	11,0	11,0	11,0	10,0	10,0	9,5	9,0	8,5
	II: 72 °C / 120 °C				9,5	9,5	9,0	8,5	8,5	8,0	7,5	7,0
Installation factor												
Dry or wet concrete		γ_{inst}	[-]	1,0								
Cracked concrete												
Characteristic bond resistance in cracked concrete C20/25												
<u>Hammer-drilling with standard drill bit or hollow drill bit (dry or wet concrete)</u>												
Tem- perature range	I: 50 °C / 80 °C		$\tau_{Rk,cr}$	[N/mm ²]	- ¹⁾	3,0	5,0	5,0	5,0	4,5	4,0	4,0
	II: 72 °C / 120 °C				- ¹⁾	3,0	4,5	4,5	4,5	4,0	3,5	3,5
Installation factor												
Dry or wet concrete		γ_{inst}	[-]	1,0								
¹⁾ No performance assessed												
fischer injection system FIS V Plus										Annex C 8		
Performances Characteristic values for combined pull-out and concrete failure for reinforcing bars; working life 50 years												

Table C9.1: Characteristic values for combined pull-out and concrete failure for fischer rebar anchors FRA in hammer drilled holes; uncracked or cracked concrete; working life 50 years								
fischer rebar anchor FRA		M12	M16	M20	M24			
Combined pullout and concrete cone failure								
Calculation diameter	d	[mm]	12	16	20	25		
Uncracked concrete								
Characteristic bond resistance in uncracked concrete C20/25								
<u>Hammer-drilling with standard drill bit or hollow drill bit (dry or wet concrete)</u>								
Tem- perature range	I: 50 °C / 80 °C		$\tau_{Rk,ucr}$	[N/mm ²]	11,0	10,0	9,5	9,5
	II: 72 °C / 120 °C				9,0	8,5	8,0	7,5
Installation factors								
Dry or wet concrete		γ_{inst}	[-]	1,0				
Cracked concrete								
Characteristic bond resistance in cracked concrete C20/25								
<u>Hammer-drilling with standard drill bit or hollow drill bit (dry or wet concrete)</u>								
Tem- perature range	I: 50 °C / 80 °C		$\tau_{Rk,cr}$	[N/mm ²]	5,0	5,0	4,5	4,0
	II: 72 °C / 120 °C				4,5	4,5	4,0	3,5
Installation factors								
Dry or wet concrete		γ_{inst}	[-]	1,0				
fischer injection system FIS V Plus						Annex C 9		
Performances Characteristic values for combined pull-out and concrete failure for fischer rebar anchors FRA; working life 50 years								

Table C10.1: Displacements for anchor rods										
Anchor rod		M6	M8	M10	M12	M16	M20	M24	M27	M30
Displacement-Factors for tension load¹⁾										
Uncracked concrete; Temperature range I, II										
δ_{N0} -Factor	[mm/(N/mm ²)]	0,09	0,09	0,09	0,10	0,10	0,10	0,10	0,11	0,12
$\delta_{N\infty}$ -Factor		0,10	0,10	0,10	0,12	0,12	0,12	0,13	0,13	0,14
Cracked concrete; Temperature range I, II										
δ_{N0} -Factor	[mm/(N/mm ²)]	- ³⁾	0,12	0,12	0,12	0,13	0,13	0,13	0,14	0,15
$\delta_{N\infty}$ -Factor		- ³⁾	0,25	0,27	0,30	0,30	0,30	0,35	0,35	0,40
Displacement-Factors for shear load²⁾										
Uncracked or cracked concrete; Temperature range I, II										
δ_{V0} -Factor	[mm/kN]	0,11	0,11	0,11	0,10	0,10	0,09	0,09	0,08	0,07
$\delta_{V\infty}$ -Factor		0,12	0,12	0,12	0,11	0,11	0,10	0,10	0,09	0,09
1) Calculation of effective displacement: $\delta_{N0} = \delta_{N0}\text{-Factor} \cdot \tau_{Ed}$ $\delta_{N\infty} = \delta_{N\infty}\text{-Factor} \cdot \tau_{Ed}$ (τ_{Ed} : Design value of the applied tensile stress)					2) Calculation of effective displacement: $\delta_{V0} = \delta_{V0}\text{-Factor} \cdot V_{Ed}$ $\delta_{V\infty} = \delta_{V\infty}\text{-Factor} \cdot V_{Ed}$ (V_{Ed} : Design value of the applied shear force)					
3) No performance assessed										
Table C10.2: Displacements for fischer internal threaded anchors RG MI										
Internal threaded anchor RG MI		M8	M10	M12	M16	M20				
Displacement-Factors for tension load¹⁾										
Uncracked concrete; Temperature range I, II										
δ_{N0} -Factor	[mm/(N/mm ²)]	0,10	0,11	0,12	0,13	0,14				
$\delta_{N\infty}$ -Factor		0,13	0,14	0,15	0,16	0,18				
Displacement-Factors for shear load²⁾										
Uncracked concrete; Temperature range I, II										
δ_{V0} -Factor	[mm/kN]	0,12	0,12	0,12	0,12	0,12				
$\delta_{V\infty}$ -Factor		0,14	0,14	0,14	0,14	0,14				
1) Calculation of effective displacement: $\delta_{N0} = \delta_{N0}\text{-Factor} \cdot \tau_{Ed}$ $\delta_{N\infty} = \delta_{N\infty}\text{-Factor} \cdot \tau_{Ed}$ (τ_{Ed} : Design value of the applied tensile stress)					2) Calculation of effective displacement: $\delta_{V0} = \delta_{V0}\text{-Factor} \cdot V_{Ed}$ $\delta_{V\infty} = \delta_{V\infty}\text{-Factor} \cdot V_{Ed}$ (V_{Ed} : Design value of the applied shear force)					
fischer injection system FIS V Plus							Annex C 10			
Performances Displacements for anchor rods and fischer internal threaded anchors RG MI										

Table C11.1: Displacements for reinforcing bars

Nominal diameter of the bar ϕ		8	10	12	14	16	20	25	28
Displacement-Factors for tension load¹⁾									
Uncracked concrete; Temperature range I, II									
δ_{N0} -Factor	[mm/(N/mm ²)]	0,09	0,09	0,10	0,10	0,10	0,10	0,10	0,11
$\delta_{N\infty}$ -Factor		0,10	0,10	0,12	0,12	0,12	0,12	0,12	0,13
Cracked concrete; Temperature range I, II									
δ_{N0} -Factor	[mm/(N/mm ²)]	- ³⁾	0,12	0,13	0,13	0,13	0,13	0,13	0,14
$\delta_{N\infty}$ -Factor		- ³⁾	0,27	0,30	0,30	0,30	0,30	0,30	0,35
Displacement-Factors for shear load²⁾									
Uncracked or cracked concrete; Temperature range I, II									
δ_{V0} -Factor	[mm/kN]	0,11	0,11	0,10	0,10	0,10	0,09	0,09	0,08
$\delta_{V\infty}$ -Factor		0,12	0,12	0,11	0,11	0,11	0,10	0,10	0,09
¹⁾ Calculation of effective displacement: $\delta_{N0} = \delta_{N0}\text{-Factor} \cdot \tau_{Ed}$ $\delta_{N\infty} = \delta_{N\infty}\text{-Factor} \cdot \tau_{Ed}$ (τ_{Ed} : Design value of the applied tensile stress)					²⁾ Calculation of effective displacement: $\delta_{V0} = \delta_{V0}\text{-Factor} \cdot V_{Ed}$ $\delta_{V\infty} = \delta_{V\infty}\text{-Factor} \cdot V_{Ed}$ (V_{Ed} : Design value of the applied shear force)				
³⁾ No performance assessed									

Table C11.2: Displacements for fischer rebar anchors FRA

fischer rebar anchor FRA		M12	M16	M20	M24
Displacement-Factors for tension load¹⁾					
Uncracked concrete; Temperature range I, II					
δ_{N0} -Factor	[mm/(N/mm ²)]	0,10	0,10	0,10	0,10
$\delta_{N\infty}$ -Factor		0,12	0,12	0,12	0,13
Cracked concrete; Temperature range I, II					
δ_{N0} -Factor	[mm/(N/mm ²)]	0,12	0,13	0,13	0,13
$\delta_{N\infty}$ -Factor		0,30	0,30	0,30	0,35
Displacement-Factors for shear load²⁾					
Uncracked or cracked concrete; Temperature range I, II					
δ_{V0} -Factor	[mm/kN]	0,10	0,10	0,09	0,09
$\delta_{V\infty}$ -Factor		0,11	0,11	0,10	0,10
¹⁾ Calculation of effective displacement: $\delta_{N0} = \delta_{N0}\text{-Factor} \cdot \tau_{Ed}$ $\delta_{N\infty} = \delta_{N\infty}\text{-Factor} \cdot \tau_{Ed}$ (τ_{Ed} : Design value of the applied tensile stress)			²⁾ Calculation of effective displacement: $\delta_{V0} = \delta_{V0}\text{-Factor} \cdot V_{Ed}$ $\delta_{V\infty} = \delta_{V\infty}\text{-Factor} \cdot V_{Ed}$ (V_{Ed} : Design value of the applied shear force)		

fischer injection system FIS V Plus

Performances

Displacements for reinforcing bars and fischer rebar anchors FRA

Annex C 11

Table C12.1: Characteristic values for steel failure under tension / shear load of fischer anchor rods and standard threaded rods under seismic action performance category C1 or C2

Anchor rod / standard threaded rod		M10	M12	M16	M20	M24	M27	M30		
Bearing capacity under tension load, steel failure¹⁾										
fischer anchor rods and standard threaded rods, performance category C1²⁾										
Characteristic resistance $N_{Rk,s,C1}$	Steel zinc plated	Property class 5.8	[kN]	29(27)	43	79	123	177	230	281
		8.8		47(43)	68	126	196	282	368	449
	Stainless steel R and high corrosion resistant steel HCR	50		29	43	79	123	177	230	281
		70		41	59	110	172	247	322	393
		80		47	68	126	196	282	368	449
fischer anchor rods, performance category C2²⁾										
Characteristic resistance $N_{Rk,s,C2}$	Steel zinc plated	Property class 5.8	[kN]	- ⁴⁾	39	72	108	- ⁴⁾	- ⁴⁾	- ⁴⁾
		8.8		- ⁴⁾	61	116	173	- ⁴⁾	- ⁴⁾	- ⁴⁾
	Stainless steel R and high corrosion resistant steel HCR	50		- ⁴⁾	39	72	108	- ⁴⁾	- ⁴⁾	- ⁴⁾
		70		- ⁴⁾	53	101	152	- ⁴⁾	- ⁴⁾	- ⁴⁾
		80		- ⁴⁾	61	116	173	- ⁴⁾	- ⁴⁾	- ⁴⁾
Bearing capacity under shear load, steel failure without lever arm¹⁾										
fischer anchor rods, performance category C1²⁾										
Characteristic resistance $V_{Rk,s,C1}$	Steel zinc plated	Property class 5.8	[kN]	17(16)	25	47	74	106	138	168
		8.8		23(21)	34	63	98	141	184	225
	Stainless steel R and high corrosion resistant steel HCR	50		15	21	39	61	89	115	141
		70		20	30	55	86	124	161	197
		80		23	34	63	98	141	184	225
Standard threaded rods, performance category C1²⁾										
Characteristic resistance $V_{Rk,s,C1}$	Steel zinc plated	Property class 5.8	[kN]	12(11)	17	33	52	74	97	118
		8.8		16(14)	24	44	69	99	129	158
	Stainless steel R and high corrosion resistant steel HCR	50		11	15	27	43	62	81	99
		70		14	21	39	60	87	113	138
		80		16	24	44	69	99	129	158
fischer anchor rods, performance category C2										
Characteristic resistance $V_{Rk,s,C2}$	Steel zinc plated	Property class 5.8	[kN]	- ⁴⁾	14	27	43	- ⁴⁾	- ⁴⁾	- ⁴⁾
		8.8		- ⁴⁾	22	44	69	- ⁴⁾	- ⁴⁾	- ⁴⁾
	Stainless steel R and high corrosion resistant steel HCR	50		- ⁴⁾	14	27	43	- ⁴⁾	- ⁴⁾	- ⁴⁾
		70		- ⁴⁾	20	39	60	- ⁴⁾	- ⁴⁾	- ⁴⁾
		80		- ⁴⁾	22	44	69	- ⁴⁾	- ⁴⁾	- ⁴⁾
Factor for the annular gap	α_{gap}	[-]	0,5 (1,0) ³⁾							
¹⁾ Partial factors for performance category C1 or C2 see table C13.1; for fischer anchor rods FIS A / RGM the factor for steel ductility is 1,0 ²⁾ Values in brackets are valid for undersized threaded rods with smaller stress area A_s and for hot dip galvanised standard threaded rods according to EN ISO 10684:2004+AC:2009. ³⁾ Values in brackets are valid for filled annular gaps between the anchor rod and the through-hole in the attachment. It is necessary to use the fischer filling disc according to Annex A 5 ⁴⁾ No performance assessed										
fischer injection system FIS V Plus								Annex C 12		
Performances Characteristic values for steel failure under tension / shear load for fischer anchor rods and standard threaded rods under seismic action (performance category C1 / C2)										

Table C13.1: Partial factors for fischer anchor rods, standard threaded rods under seismic action performance category C1 or C2

Anchor rod / standard threaded rod		M10	M12	M16	M20	M24	M27	M30
Tension load, steel failure¹⁾								
Partial factor $\gamma_{Ms,N}$	Steel zinc plated	Property class	5.8	[-]	1,50			
			8.8		1,50			
	Stainless steel R and high corrosion resistant steel HCR	50	2,86					
		70	1,50 ²⁾ / 1,87					
		80	1,60					
Shear load, steel failure¹⁾								
Partial factor $\gamma_{Ms,V}$	Steel zinc plated	Property class	5.8	[-]	1,25			
			8.8		1,25			
	Stainless steel R and high corrosion resistant steel HCR	50	2,38					
		70	1,25 ²⁾ / 1,56					
		80	1,33					

¹⁾ In absence of other national regulations

²⁾ Only admissible for high corrosion resistant steel HCR, with $f_{yk} / f_{uk} \geq 0,8$ and $A_5 > 12\%$ (e.g. fischer anchor rods)

fischer injection system FIS V Plus

Performances

Partial factors under seismic action (performance category C1 and C2) for fischer anchor rods and standard threaded rods

Annex C 13

Table C14.1: Characteristic values for combined pull-out and concrete failure for **fischer anchor rods** and **standard threaded rods** in hammer drilled holes under seismic action performance category **C1, working life 50 and 100 years**

Anchor rod / standard threaded rod		M10	M12	M16	M20	M24	M27	M30		
Characteristic bond resistance, combined pullout and concrete cone failure										
Hammer-drilling with standard drill bit or hollow drill bit (dry or wet concrete)										
Tem- perature range	I: 50 °C / 80 °C	$\tau_{Rk,C1}$	[N/mm ²]	4,5	5,5	5,5	5,5	4,5	4,0	4,0
	II: 72 °C / 120 °C			4,0	4,5	4,5	4,5	4,0	3,5	3,5
Hammer-drilling with standard drill bit or hollow drill bit (water filled hole)										
Tem- perature range	I: 50 °C / 80 °C	$\tau_{Rk,C1}$	[N/mm ²]	- ¹⁾	5,0	5,0	4,5	4,0	3,5	3,5
	II: 72 °C / 120 °C			- ¹⁾	4,0	4,0	4,0	3,5	3,0	3,0
Installation factors										
Dry or wet concrete	γ_{inst}	[-]	1,0							
Water filled hole			- ¹⁾	1,2						

¹⁾ No performance assessed

fischer injection system FIS V Plus

Performances

Characteristic values under seismic action (performance category C1) for fischer anchor rods and standard threaded rods, working life 50 and 100 years

Annex C 14

Table C15.1: Characteristic values for combined pull-out and concrete failure for **fischer anchor rods** in hammer drilled holes under seismic action performance category **C2**; **working life 50 and 100 years**

Anchor rod / standard threaded rod		M12	M16	M20	
Characteristic bond resistance, combined pullout and concrete cone failure					
Hammer-drilling with standard drill bit or hollow drill bit (dry or wet concrete)					
Tem- perature range	I: 50 °C / 80 °C	$\tau_{Rk,C2}$ [N/mm ²]	1,5	1,3	2,1
	II: 72 °C / 120 °C		1,3	1,2	1,9
Hammer-drilling with standard drill bit or hollow drill bit (water filled hole)					
Tem- perature range	I: 50 °C / 80 °C	$\tau_{Rk,C2}$ [N/mm ²]	1,3	1,1	1,8
	II: 72 °C / 120 °C		1,1	1,0	1,6
Displacement-Factors for tension load¹⁾					
$\delta_{N,C2}$ (DLS)-Factor	[mm/(N/mm ²)]	0,20	0,13	0,21	
$\delta_{N,C2}$ (ULS)-Factor		0,38	0,18	0,24	
Displacement-Factors for shear load²⁾					
$\delta_{V,C2}$ (DLS)-Factor	[mm/kN]	0,18	0,10	0,07	
$\delta_{V,C2}$ (ULS)-Factor		0,25	0,14	0,11	

1) Calculation of effective displacement:

$$\delta_{N,C2} (DLS) = \delta_{N,C2} (DLS)\text{-Factor} \cdot \tau_{Ed}$$

$$\delta_{N,C2} (ULS) = \delta_{N,C2} (ULS)\text{-Factor} \cdot \tau_{Ed}$$

(τ_{Ed} : Design value of the applied tensile stress)

3) No performance assessed

2) Calculation of effective displacement:

$$\delta_{V,C2} (DLS) = \delta_{V,C2} (DLS)\text{-Factor} \cdot V_{Ed}$$

$$\delta_{V,C2} (ULS) = \delta_{V,C2} (ULS)\text{-Factor} \cdot V_{Ed}$$

(V_{Ed} : Design value of the applied shear force)

fischer injection system FIS V Plus

Performances

Characteristic values under seismic action (performance category C2) for fischer anchor rods; working life 50 and 100 years

Annex C 15